

Bushing

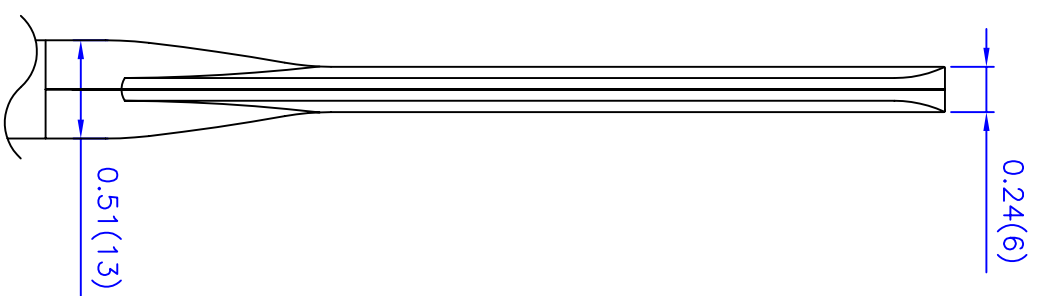
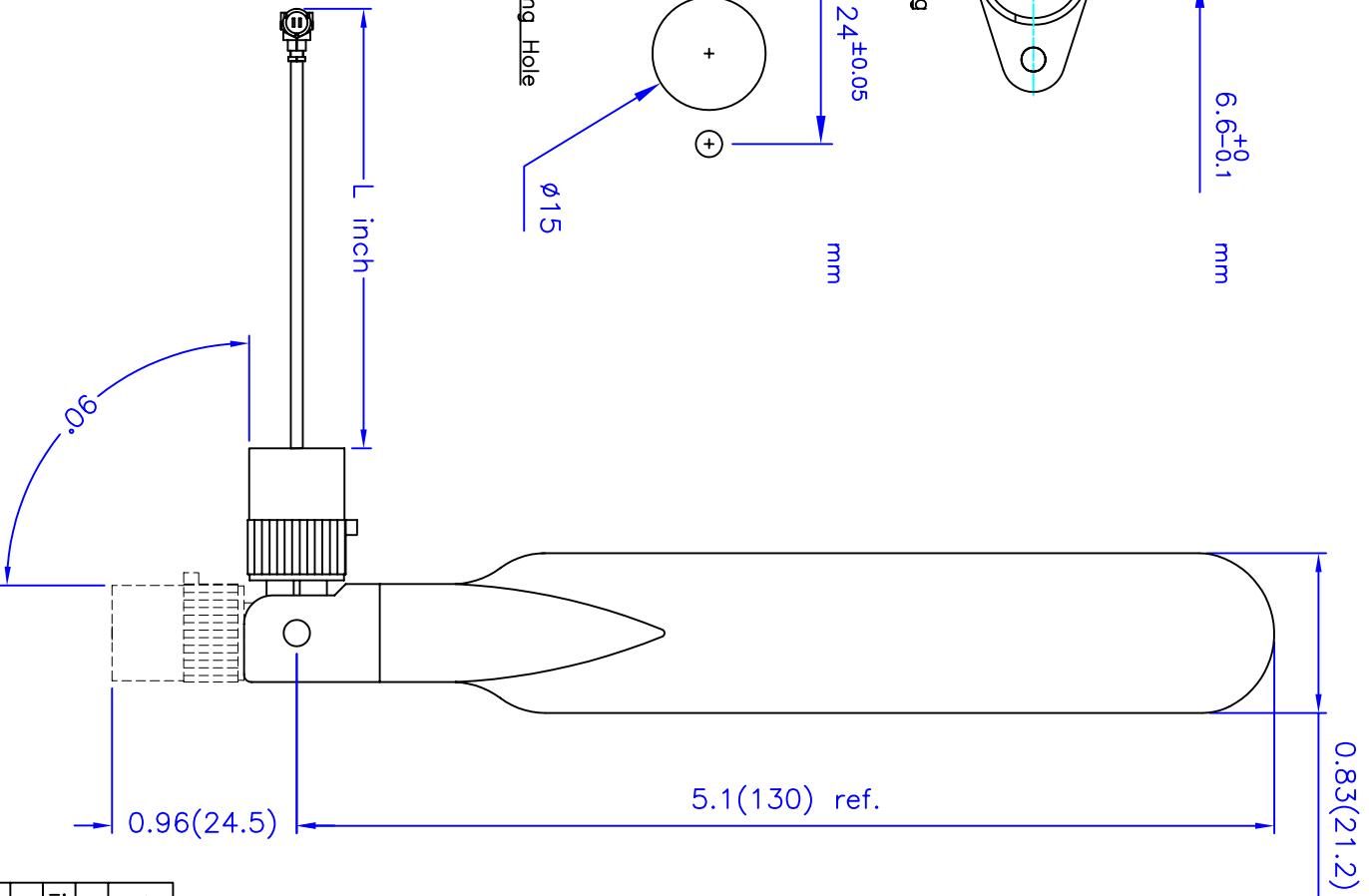
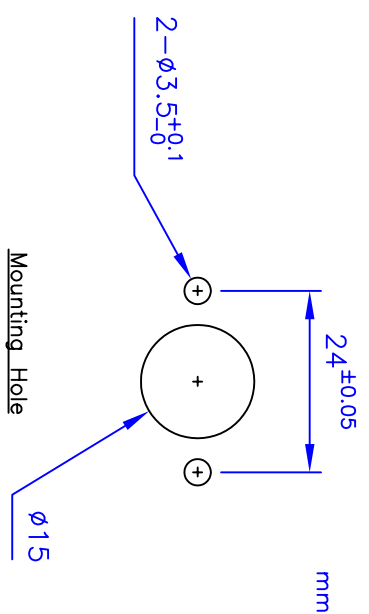

TITLE	2.4/5.2/5.8GHz Fixed Mount Swivel Antenna-614 Model	DATE	SHEET
UNIT	in.(mm)		1 of 2
SCALE	None	DWG. NO. T614FC-L-(132)PX-2.4/5.X-S	
NEARSON			
http://www.nearson.com			

E-Plane Pattern

H-Plane Pattern

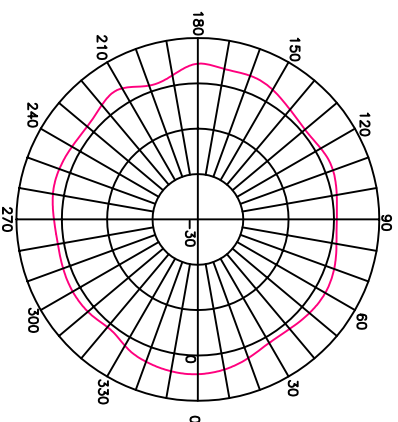
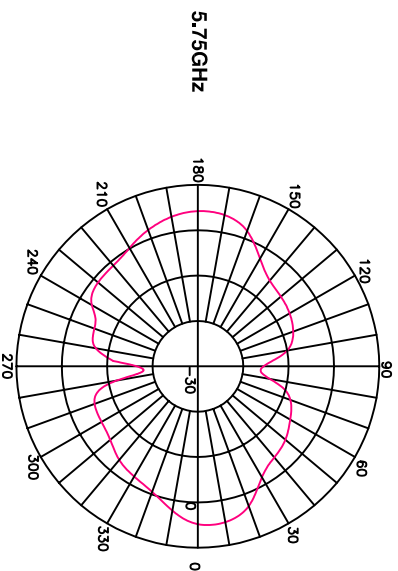
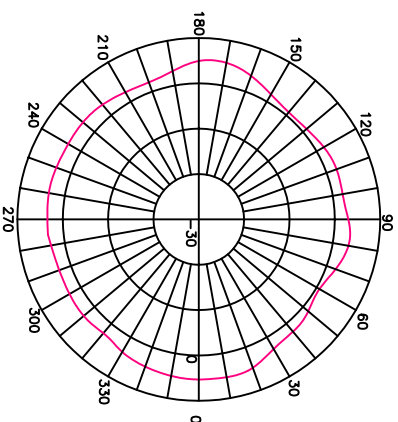
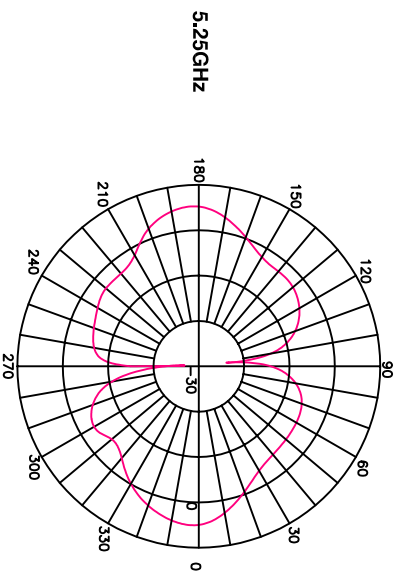
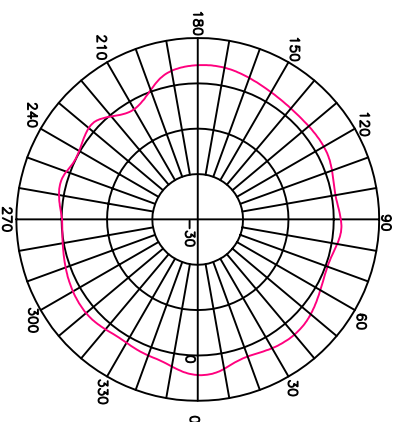
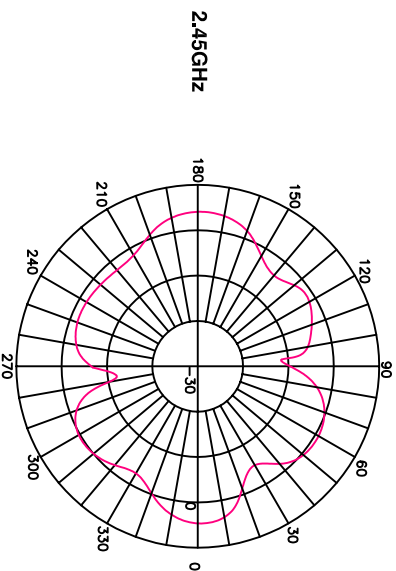

Electrical Properties:

- Frequency Range: 2.4~2.5 GHz
5.15~5.85 GHz
- Impedance: 50Ω nominal
- VSWR: <2.0:1
- Gain*: 2.45GHz 4.0 dBi
5.25GHz 5.0 dBi
5.75GHz 4.5 dBi
- Radiation: Omni
- Polarization: Vertical

*Cable loss is not included.

Mechanical Properties:

- Cable: 1.32 mm diameter, 50-ohm coaxial specified in inch.
- Cable Length: Hirose U.FL compatible(female);
- Connector: Material: Polyurethane(Black); BASF and Polycarbonate(Black); Bayer
- Overmold: Swivel: Polyurethane(Black); BASF and Polycarbonate(Black); Bayer
- Operation Temp.: -20°C to +65°C
- Storage Temp.: -30°C to +75°C

TITLE	2.4/5.2/5.8GHz Fixed Mount Swivel Antenna-614 Model		DATE	SHEET
UNIT	in.(mm)			2 of 2
SCALE	None			
DWG. NO.		T614FC-L-(132)PX-2.4/5.X-S		
NEARSON				